

RITM OKB ZAO

TRANSCUTANEOUS ELECTROSTIMULATORS

**SCENAR Home D,
SCENAR Sport D,
SCENAR Basic D**

OPERATING MANUAL



MANUFACTURER

RITM OKB ZAO

99, Petrovskaya str., Taganrog, Russia, 347900

Tel/Fax: +7 (8634) 62-31-79

www.scenar.com.ru e-mail: medsc@scenar.com.ru

AUTHORIZED REPRESENTATIVE

SCENAR Center – Bulgaria ltd.

9, V. Aprilov blvd. Plovdiv, 4002, Bulgaria

phone: (+3-59-32) 641-001 e-mail: office@bgscenar.org

**IMPORTANT INFORMATION!*****PLEASE READ THIS PAGE CAREFULLY***

WARNING! This device should NOT be used on an individual who has a heart pacemaker or other electrically powered implant fitted.

WARNING! Application of electrodes near the thorax may increase the risk of cardiac fibrillation.

WARNING! Simultaneous connection of a patient to h.f. surgical equipment may result in burns at the site of the stimulator electrodes and possible damage to the stimulator.

WARNING! Operation in close proximity (e.g. 1 m) to shortwave or microwave therapy equipment and mobile communicators may produce instability in the stimulator output.

WARNING! Aged people, children, and people with disabilities may not use the stimulator.

WARNING! The device needs special precautions regarding EMC and needs to be installed and put into service according to the EMC information provided in Annex 1.

WARNING! As the current densities for electrodes exceed 2 mA r.m.s./cm^2 , the device requires the special attention of the user.

WARNING! The device should not be used adjacent to or stacked with other equipment.

This appliance is marked according to the European directive 2002/96/EC on Waste Electrical and Electronic Equipment (WEEE). By ensuring this product is disposed of correctly, you will help prevent potential negative consequences for the environment and human health, which could otherwise be caused by inappropriate waste handling of this product.

The  symbol on the documents accompanying the product indicates that this appliance may not be treated as household waste. Instead it shall be handed over to the applicable collection point for the recycling of electrical and electronic equipment.

Disposal must be carried out in accordance with local environmental regulations for waste disposal.

For more detailed information about treatment, recovery and recycling of this product, please contact your local city office, your household waste disposal service or the shop where you purchased the product.

Origin: RITM OKB ZAO, 99, Petrovskaya str., Taganrog, Rostov region, 347900, Russia.

Model(s): SCENAR Home D, SCENAR Sport D, SCENAR Basic D.

Classification: *Type of protection against electric shock* – Internally powered equipment (9 V battery) *Degree of protection against electric shock* – Type BF.

Waterproofing: No special protection against liquid ingress provided (IPX0).

Cleaning & Disinfecting: Wipe electrode area with a cotton swab dampened with 3 % hydrogen peroxide solution with the addition of 0.5 % solution of an approved cleaning liquid. Allow to dry up thoroughly before use.

Clinical environment: NOT suitable for use in the presence of flammable anaesthetic mixtures with air, oxygen or nitrous oxides.





DO NOT REMOVE the upper casing – this access is for the use of service personnel only.

Batteries: Remove battery from device if not in use for an extended period. Connect correctly.

DO NOT TRY TO RECHARGE disposable batteries! Dispose of used batteries responsibly. Use good quality, within-date long-life, 9 V ALKALINE Type 6F22KG, 1604, 6LR61.

Note: *Remove battery during storage and transportation to avoid battery drain. Do not operate the device with the battery cover removed, as this exposes the operator to live battery circuits in contravention of the Safety Regulations.*

MARKS AND SYMBOLS ON THE DEVICE LABEL

	<p>THIS CE SYMBOL CERTIFIES THAT THE PRODUCT COMPLIES WITH THE ESSENTIAL REQUIREMENTS OF THE MEDICAL DEVICE DIRECTIVE</p> <p>Notified Body No.2265 3EC International a.s., Hraničná 18, Bratislava, 82105, Slovakia</p>
	<p>APPLIED PARTS – TYPE BF</p>
 <p>RITM OKB ZAO 99 Petrovskaya Str, Taganrog, 347900, RUSSIA 2012</p>	<p>MANUFACTURER combined with DATE OF MANUFACTURE</p>
<p>SN-XXXX</p>	<p>SERIAL NUMBER</p>
	<p>CONSULT INSTRUCTIONS FOR USE</p>
	<p>AUTHORISED REPRESENTATIVE IN THE EUROPEAN COMMUNITY</p>

DEFINITIONS

Amplitude modulation (Am) is a periodic variation of stimuli amplitude (as well as **stimuli Energy**). **Am** is defined as the ratio of the time the device is sending pulses with preset **Energy** to that with minimal **Energy**. For example, the '3:1' **Am** setting indicates that the device is transmitting **stimuli** with preset **Energy** for 3 seconds and then with **Energy** = 1 for 1 second. **Amplitude modulation** manifests itself as strengthening and weakening the specific sensations with a set period.

Dose is a signal to the operator that the rate of skin **impedance** change has sufficiently reduced.

Dosed Stimulation determines the type of dosing provided by the device. When the **Dosed Stimulation** is switched ON, the stimulation time for a zone is determined automatically. When the **Dosed Stimulation** is switched OFF, the zones to be treated, stimulation time for each zone and time of the whole session are determined by the therapist.

Energy is a parameter determining strength of every stimulus. The **Energy** influences **stimulus** amplitude and strength of stimulation sensation. The higher the **Energy**, the stronger the specific sensations felt by the patient.

Electrodes – cutaneous electrodes (built-in electrode and add-on electrodes) that are applied directly to patient's skin for electrical stimulation.

Frequency (F) is a number of **stimuli** (or **stimuli** bursts) per second, measured in Hertz (Hz). When **Frequency** changes the strength and 'volume' of sensations also change.

Frequency modulation (Fm) is a periodical change of **stimuli Frequency** from initial to final **Frequency** value and back. The sensations are similar to those accompanying manual **Frequency** change.

Impedance is determined by the combined physical characteristics of the skin, defining its ability to absorb the **Energy** generated by the device.

Stimulus is a single two-phase output pulse.

Timer indicates how long the device is in contact with the patient's skin.

CONTENTS

MARKS AND SYMBOLS ON THE DEVICE LABEL	4
DEFINITIONS	5
1 PURPOSE.....	7
2 SPECIFICATIONS.....	8
3 PACKAGE CONTENTS.....	11
4 SCENAR DEVICE OVERVIEW	12
4.1 SCENAR HOME D AND SCENAR SPORT D	12
4.2 SCENAR BASIC D	22
5 GETTING STARTED.....	27
5.1 SCENAR HOME D AND SCENAR SPORT D	27
5.2 SCENAR BASIC D.....	29
6 USING SCENAR DEVICE	30
6.1 SCENAR HOME D AND SCENAR SPORT D	30
6.2 SCENAR BASIC D.....	31
7 MAINTENANCE	32
8 TROUBLESHOOTING	33
9 WARRANTY	35
10 TRANSPORTATION AND STORAGE	36
ANNEX 1	37

1 PURPOSE

- **SCENAR Home D** biofeedback transcutaneous electrostimulator with individual dosing of reflex zone stimulation;
- **SCENAR Sport D** transcutaneous three-mode electrostimulator with individual dosing of reflex zone stimulation;
- **SCENAR Basic D** transcutaneous dual-mode electrostimulator with individual dosing of reflex zone stimulation.

SCENAR Home D, SCENAR Sport D, SCENAR Basic D transcutaneous electrostimulators (hereinafter called the SCENAR device or the device or SCENAR) are intended for general therapeutic non-invasive treatment of the human skin in order to remove pain of different etiology, alleviate diseases, and speed up the recovery process of the organs and systems in the course of combined therapy of different diseases.

The SCENAR device can be used:

- by home users and in medical and prophylactic institutions to remove or reduce pain syndromes of various genesis, swelling, to speed up the recovery process and prevent complications after traumas of any kind and also to restore dysfunctions of the body in various diseases;
- only in medical and prophylactic institutions – as a stand-alone treatment or alongside other therapies to remove postsurgical pain syndrome and acute pain (including renal colic).

The SCENAR device is intended for use over a temperature range of 10 °C to 35 °C, and relative humidity up to 80 % at 25 °C.

Potential risk from the device usage refers to Class IIa (2a) DIRECTIVE 93/42/EEC (GOST R 31508).

The device complies with the standards EN 60601-1 (GOST R 50267.0) and EN 60601-2-10 (GOST R 50267.10) for internally powered equipment, type BF, which classifies it as a safe device for personal use.

2 SPECIFICATIONS

2.1 Power supply: one 9 V alkaline battery.

2.2 Current consumption: max – 85 mA.

2.3 At a load (see Fig.1) SCENAR performs:

- generation of two-phase stimuli without a DC-component (see Fig.2) with a waveform depending on the skin impedance under the electrode (see Fig.3 through 5):
- control of the stimulus' 1st phase duration (see Fig.2) within (4 ± 2) to (500 ± 50) μ sec, meanwhile the amplitude of the first pulse of the stimulus' 2nd phase at L1 load (see Fig.1) varies from $(1.7 \dots 2.8)$ V to $(100 \dots 150)$ V, amplitude control step – max 1 V.

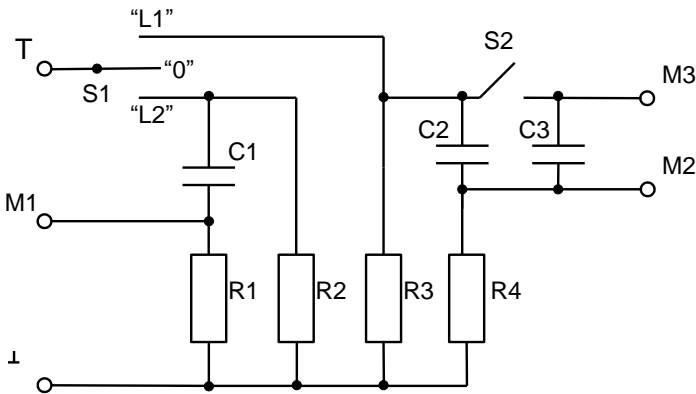

C1	K73-11-630 V-2200 pF \pm 10 %
C2, C3	K73-11-250 V-0.033 μ F \pm 10 %
R1	1/4W 11 k Ω \pm 5 %
R2, R3	1/4W 91 k Ω \pm 5 %
R4	1/4W 560 Ω \pm 5 %

M1...M3 are measuring points

Fig.1

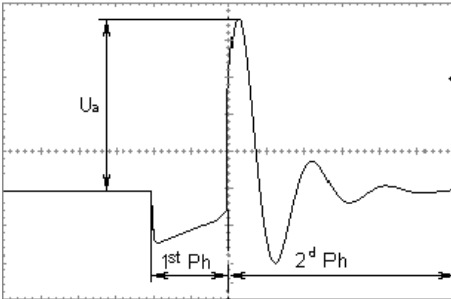

1st Ph – stimulus' 1st phase duration
 2^d Ph – stimulus' 2nd phase duration
 U_a – stimulus' 2nd phase 1st pulse amplitude

Fig.2

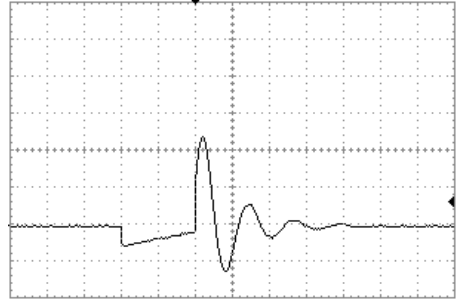

Load L1; S2 – 'Off',
 load capacity – 33 nF

Fig.3

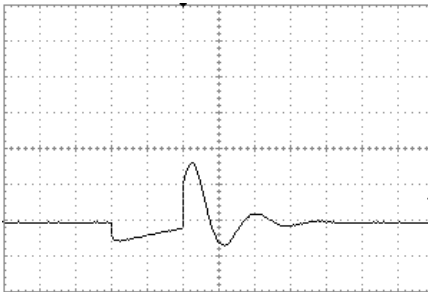

Load L1, S2 – 'On',
 load capacity – 66 nF

Fig.4

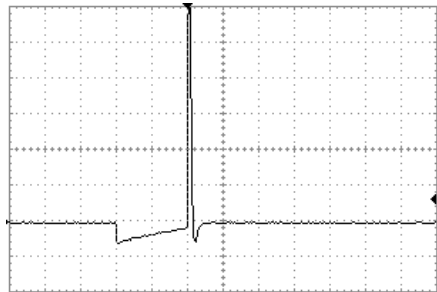

Load L2,
 load capacity – 2.2 nF

Fig.5

2.4 Fixed stimuli frequencies:

- SCENAR Home D – 90 Hz ± 10 %;
- SCENAR Sport D – 14, 60, 90, 340 Hz ± 10 %;
- SCENAR Basic D – 60, 90 Hz ± 10 %.

2.5 Frequency modulation ('FM') with the following parameters (only for SCENAR Home D and SCENAR Sport D):

- frequency range – (30 ± 3) to (120 ± 12) Hz;
- cycle of modulation – (7 ± 2) sec.

2.6 Amplitude modulation ('AM', see Fig.6) with the following parameters:

- duration of stimuli bursts with set amplitude – (3.0 ± 0.5) sec;
- pause (stimuli bursts with minimum amplitude value) duration – (1.0 ± 0.3) sec.

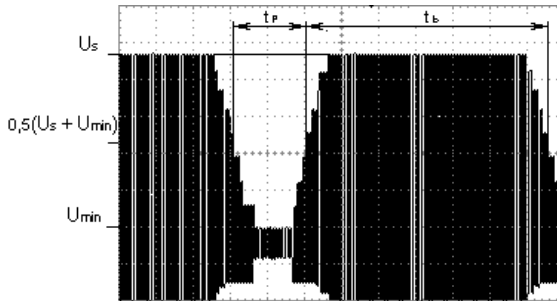

U_{\min} – minimum amplitude
 U_s – set amplitude
 t_p – pause duration
 t_b – stimuli burst duration

Fig.6

2.7 Time of dosed stimulation with L1 load:

- SCENAR Home D – 20 to 40 sec;
- SCENAR Sport D – 30 to 60 sec;
- SCENAR Basic D – 45 to 75 sec.

2.8 SCENAR device automatic turn-off time – (60 ± 20) sec.

2.9 SCENAR device weight: max – 0.2 kg.

2.10 Overall dimensions: max – 140 x 55 x 35 mm.

2.11 Average service life: min – 5 years.

3 PACKAGE CONTENTS

See Table 1 for SCENAR complete delivery set.

Table 1

Item	Quantity (units)
SCENAR Home D – a biofeedback transcutaneous electrostimulator with individual dosing of reflex zone stimulation.	□
SCENAR Sport D – a transcutaneous triple-mode electrostimulator with individual dosing of reflex zone stimulation.	□
SCENAR Basic D – a transcutaneous dual-mode electrostimulator with individual dosing of reflex zone stimulation.	□
9 V PP3 type battery (6F22KG, 1604)	1
Case	1
Consumer packaging	1
Operating Manual	1
Instruction for Use	1
<p>Note:</p> <p>1) On the customer's request, SCENAR devices can be completed with the following add-on electrodes:</p> <ul style="list-style-type: none"> – Face electrode – Comb electrode – Point electrode – Special Snail electrode – Bent point electrode – Double facial Pawns electrode – Double cosmetic electrode – Double ophthalmic Goggles electrode – Double facial Stamps electrode – Single ophthalmic Monocle electrode – Special double Pencils electrode – Large comb electrode – Multi-purpose zonal electrode <p>2) Add-on electrodes listed in item 1) can be purchased on the customer's request at extra cost.</p>	

4 SCENAR DEVICE OVERVIEW

4.1 SCENAR HOME D AND SCENAR SPORT D

Fig.7 shows the SCENAR device exterior.

4.1.1 On the back side of the casing (1) there is a built-in electrode (2) and a battery cover (8).



Fig.7

4.1.2 On the front side of the casing there is a liquid crystal display (LCD) (3) for the visual indication and a keyboard (four buttons):

- 4 – ‘□’ button switches the SCENAR device ON and OFF;
- 5 – ‘✓’ button preselects the desired stimulation mode;
- 6 – ‘+’ button activates the preselected mode or increases the energy level (stimulus strength);
- 7 – ‘-’ button deactivates the preselected mode or decreases the energy level (stimulus strength).

4.1.3 The information can be displayed on the screen in a **general** or a **single-line** view.

Information is displayed in two lines in a **general** view (Fig.8).

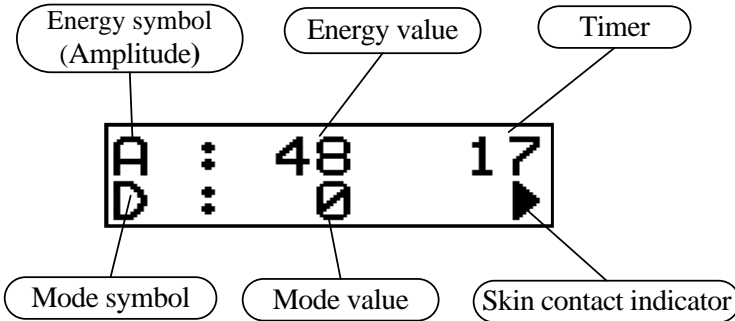

Fig.8

The following data is displayed on the screen:

- a symbol of stimulation energy (amplitude) ('A') and its value in units (from 1 to 250);
- a timer in a 'm ss' format (m – minutes, ss – seconds);
- a symbol of the last set stimulation mode:
 - ◆ for SCENAR Sport D – 'D', 'AM', 'FM', 'F';
 - ◆ for SCENAR Home D – 'D', 'AM', 'FM';
 and its value;
- an indicator of skin contact.



ATTENTION! All set stimulation modes (except for energy) are retained after the SCENAR is switched off.

In a **single-line** view the information is displayed in large font-size. The SCENAR device switches to a **single-line** view:

- when adjusting the stimulation energy (Fig.9);
- when preselecting the stimulation modes (Fig.10);
- when working in the dosed stimulation mode (Fig.11 and 12).



Fig.9



Fig.10



Fig.11



Fig.12

When switching to a **single-line** view, the backlight turns on; the skin contact indicator (‘▶’) is not displayed.

The screen returns to a **general** view after 2 seconds if no button has been pressed.

4.1.4 On the left side of the casing there is a jack (9) intended for connecting the add-on electrodes which can be supplied additionally upon request.



ATTENTION! Only the add-on electrodes produced by the SCENAR manufacturer can be used. Be careful: use only plug-compatible add-on electrodes. Using the incompatible or produced by the other manufacturer add-on electrodes may result in damaging the jack and making the warranty invalid!

4.1.5 To adjust the energy level (from 1 to 250) either press the button step by step (1 step = 1 unit) or press and hold the button (speedy adjustment). A long beep indicates the upper (or lower) energy level limit. Changing of the energy level is accompanied by clicks at the adjustment rate, switching the backlight on and changing ‘A’ value on the screen, meanwhile the information is displayed in a **single-line** view (Fig.13).



ATTENTION! To avoid uncomfortable and painful sensations of a patient, it is recommended to set the energy to minimum (by pressing and holding the ‘—’ button until the intermittent audio signal sounds) before the start of procedure or when going to treat the most sensitive skin areas.

Upon returning to a **general** view the set ‘A’ value is displayed in the upper line (Fig.14).



Fig.13

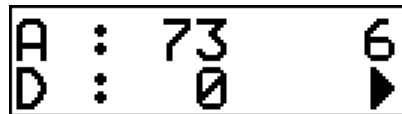

Fig.14

4.1.6 To set the Dosing mode, press the ‘✔’ button (sequence of single taps) until the ‘D’ symbol appears on the screen. While the ‘D’ symbol is on the screen, press the ‘+’ button to switch the mode on, and the ‘—’ button – to switch it off. The mode switching on is accompanied by an ascending two-tone beep and changing the ‘D’ value to ‘1’ (Fig.15), the switching off – with a descending two-tone beep and changing the ‘D’ value to ‘0’ (Fig.16). Upon returning to a **general** view the set ‘D’ value is displayed in the bottom line (Fig.17).



Fig.15



Fig.16

In the Dosing mode when the electrode is placed on the skin, a short high-pitch beep sounds. The screen switches to a **single-line** view and the initial state of the timer ('0') is indicated on the right (Fig.18). Then the timer starts. In 1-3 sec a short low-pitch beep sounds and the backlight flashes on shortly.

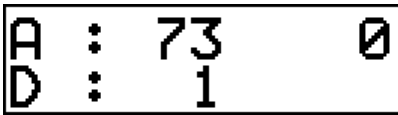

Fig.17



Fig.18

(Optional) SCENAR graphically indicates a level of initial reaction during one second after the second beep:

Reaction level		Indication
	Reaction < 18	no indication (Fig.19)
18 <=	Reaction < 25	one symbol 'I' displayed (I) (Fig.20)
25 <=	Reaction < 40	two symbols 'I' displayed (II) (Fig.21)
40 <=	Reaction < 60	three symbols 'I' displayed (III) (Fig.22)
60 <=	Reaction	four symbols 'I' displayed (IIII) (Fig.23)

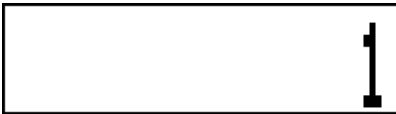

Fig.19

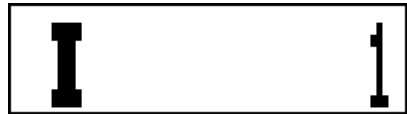

Fig.20



Fig.21



Fig.22



Fig.23

While delivering the dose, the ‘**I**’ symbols appear on the screen (by one or several together), the timer on the right shows the time of continuous contact with the skin (Fig.24), single beeps may sound – depending on the dose delivery rate. The rate of appearance of the ‘**I**’ symbols and the number of intermediate beeps can vary on different skin areas.

When the dose is reached, the ‘*DOSE*’ message appears on the screen (Fig.25) and a two-tone beep sounds.



Fig.24



Fig.25

(Optional) The ‘**D2**’ mode is intended for searching skin areas with maximal reaction in a labile mode. If the current reaction exceeds the previous maximum, this is indicated by a **clicking sound**. The current reaction to the initial reaction ratio is indicated in the screen:

The current to the initial reaction ratio		Indication
	Ratio < 1/2	no indication
1/2 <=	Ratio < 1	one symbol ‘ I ’ displayed (I)
1 <=	Ratio < 1 1/2	two symbols ‘ I ’ displayed (II)
1 1/2 <=	Ratio < 2	three symbols ‘ I ’ displayed (III) and the device emits a single beep every second
2 <=	Ratio	four symbols ‘ I ’ displayed (IIII) and the device emits double beep every second

The graphical indication is the same as in ‘**D1**’ mode (Fig.19...23).



ATTENTION! In fact there is a double indication: a relative value of current reaction to initial one – in the screen and by sounds, and an absolute maximum of reaction – by **clicks**.

4.1.7 To set the ‘**AM**’ mode, press the ‘**✓**’ button (sequence of single taps) until the ‘**AM**’ symbol appears on the screen. Press the ‘**+**’ button to switch the mode on, and press the ‘**—**’ button to switch it off. The mode switching on is accompanied by an ascending two-tone beep and changing the ‘**AM**’ value to ‘**1**’ (Fig.26), the switching off – with a descending two-tone beep and changing the ‘**AM**’ value to ‘**0**’ (Fig.27). Upon returning to a **general** view the set ‘**AM**’ value is displayed in the bottom line (Fig.28).



Fig.26



Fig.27



Fig.28

In the Amplitude modulation mode the stimulation is intermittent: 3 sec – stimulation, 1 sec – pause.

4.1.8 To set the 'FM' mode follow the same rules as for setting the 'AM' mode (Fig.29...31).

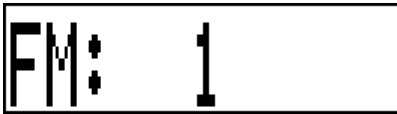

Fig.29



Fig.30

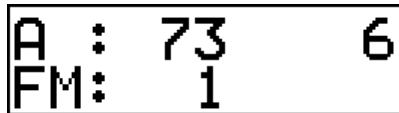

Fig.31

In the Frequency modulation mode the stimulation frequency is continuously changing from 30 to 120 Hz and back.

4.1.9 SCENAR Home D device has only one frequency (90 Hz). SCENAR Sport D device has four frequencies (14, 60, 90 and 340 Hz). To select the stimulation frequency press the '✓' button (sequence of single taps) until the 'F' symbol appears on the screen. To select the stimulation frequency press the '+' or '-' button. The frequency selection is indicated by changing the 'F' value and is accompanied by short beeps:

- 14 Hz – one beep (Fig.32);
- 60 Hz – two beeps (Fig.33);
- 90 Hz – three beeps (Fig.34);
- 340 Hz – four beeps (Fig.35).

Upon returning to a **general** view the set 'F' value is displayed in the bottom line (Fig.36).



Fig.32



Fig.33



Fig.34



Fig.35

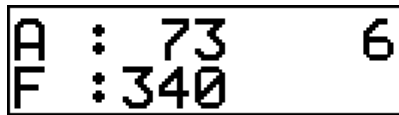

Fig.36

(SCENAR Sport D only) When the 'FM' mode is on, the frequency set in the 'F' mode is disregarded and the frequency selection is blocked. When the 'FM' mode is switched off, the previously used frequency is set.

4.1.10 Some modes may be used together: 'D+Am' (at any frequency for SCENAR Sport D only), 'D+Fm', 'D+Am+Fm', 'Am+Fm'. For this purpose, switch on the required modes sequentially.

(Optional) For users' convenience SCENAR has two preset modes (**Presets**).

To enter the **Presets** menu press the '✓' button several times until the 'P' symbol appears on the screen. Then press the '+' button to select one of two presets. The chosen **Preset** also has the sound indication:

➤ **Preset 1** – 'P1' or 'ACUTE' (indicated by single beep): the influence is performed by batches of pulses; the number of pulses in the batch and the gap between them is controlled automatically depending on the impedance of the interelectrode tissues. The pulse rate is selected automatically between 15 and 340 Hz according to the preset program (Fig.37). The preset program has four phases.

➤ **Preset 2** – 'P2' or 'SYSTEM' (indicated by double beep): the pulse rate is controlled automatically according to the preset program (Fig.38). The preset program has three phases.

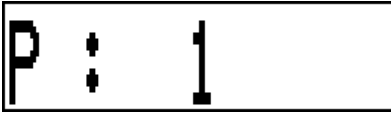

Fig.37



Fig.38

When you return to the **overview** mode, the screen shows the current stage of the preset program. The information is displayed in a one-line form (Fig.39).

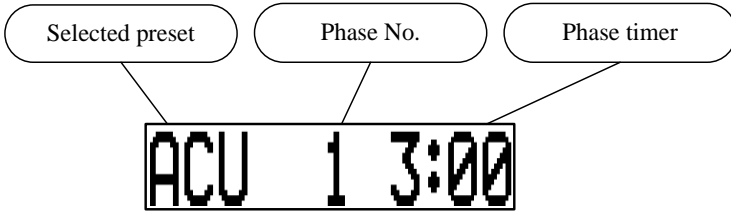



Fig.39

The selected preset is indicated by the shortened name: **Preset 1** – ‘ACU’, **Preset 2** – ‘SYS’. The preset program has several phases, each of which runs for a given time. The phase timer works in a countdown mode and shows the time remaining to the end of the current preset phase on the screen. The beginning of new preset phase is indicated by a dual-tone sound. At the end of the last preset phase, the device will turn off automatically.

It is not possible to adjust the duration of each separate phase of the preset. To set the duration of the preset program press the combination of ‘’ and ‘’ buttons at the same time. The device will enter the preset operating time setting mode (Fig.40).



ATTENTION! Do not hold the above button combination for more than 2 sec, since that will cause the device reset and loss of all previous settings.

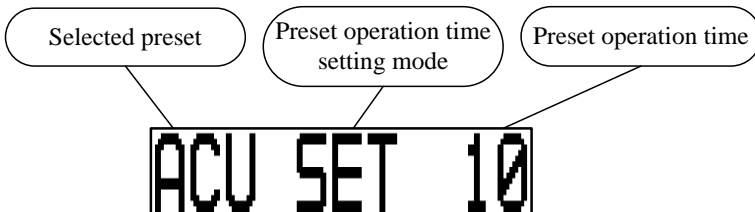

Fig.40

The full preset operation time is set in minutes and shown in the right part of the screen.

When in the preset operation time setting mode, use ‘+’ and ‘-’ buttons to set the operation time from **1** to **29**. Reaching the minimum or maximum limit of the set value is indicated by a long beep

When the operation time is changed, the durations of the preset phases will be automatically calculated and the preset program will be restarted with the first phase set, regardless of the number of the currently executed phase.

When any **preset** is turned on, the subsequent pressing of the ‘☑’ button will lead to switching between the ‘P’ menu (Fig.37 or Fig.38) and the preset operation time setting mode (Fig.40). Selection of any other menu item by pressing the ‘☑’ button is impossible when the preset is on. To enable all the **menu** items again, you need to turn off the **preset** or reset the device.

To turn the **preset** off, subsequently press the ‘☑’ button until the selected preset appears on the screen (Fig.37 or Fig.38), and then press the ‘-’ button while the selected **preset** is shown on the screen. When the **preset** is turned off (Fig.41), the long low-tone beep will appear, the **energy** value set during the preset activation will be restored, and the other pulse parameters will be set to their default values (‘F’ = 60 Hz; ‘FM’, ‘AM’, ‘D1’ and ‘D2’ are switched off).



Fig.41

(Optional) For users’ convenience there is a quick transition to **Preset 1** by simultaneous pressing of ‘+’ and ‘-’ buttons.



ATTENTION! When you turn on a preset, the set energy value is saved. When executing a preset program, the energy value can change automatically. When you turn off a preset, the energy value saved when you entered the preset will be set. **To avoid unpleasant and painful sensations for the patient**, after turning off the preset, reduce the energy to a minimum (press and hold the ‘-’ button until a long beep appears).

4.1.11 The timer shows the duration of continuous contact with the skin in the ‘m ss’ format (m – minutes, ss – seconds). In a **general** view the timer is displayed in the upper line on the right (Fig.42-a).



Fig.42-a



Fig.42-b

If a Dosed mode is OFF, the timer resets when there is a new skin contact, when the timer is overflowed (reaches values of 9 minutes and 59 seconds) and when the device is switched on.

When adjusting the energy level or preselecting the stimulation modes while there is a skin contact, the timer is not displayed, but the timing continues.

In a Dosed mode the timer runs in a **single-line** view only (during the skin contact, Fig.42-b). When the skin contact is lost, the screen returns to a **general** view, the timer stops and indication remains unchanged.

4.1.12 Enabling/disabling sounds:

- to enable sounds, press the '☑' and '+' buttons simultaneously (the SCENAR device emits a beep);
- to disable sounds, press the '☑' and '-' buttons simultaneously (no sounds).

4.1.13 (Optional) To lock/unlock a keyboard press and hold the '☐' and '-' buttons (for about 2 sec) until the SCENAR device emits a two-tone descending/ascending beep. When the keyboard is locked the 'x' symbols are displayed instead of the ':' symbols (Fig.43).

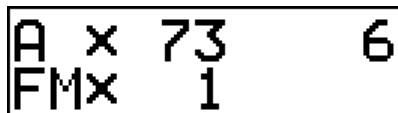

Fig.43

If the SCENAR device switches off automatically, the keyboard will be unlocked when the SCENAR device is switched on next time.

4.1.14 To switch the SCENAR device on with the energy level set before it was switched off press and hold the '☐' and '+' buttons (for about 2 sec) until the SCENAR device emits an intermittent high-pitch beep.



ATTENTION! When the SCENAR device is switched on with the energy level set before it was switched off, the sound indication is different from default.

4.2 SCENAR BASIC D

Fig.44 shows the SCENAR Basic D device exterior.

4.2.1 On the back side of the casing (1) there is a built-in electrode (2) and a battery cover (8).



Fig.44

4.2.2 On the front side of the casing there is a liquid crystal display (LCD) (3) for the visual indication and a keyboard (four buttons):

- 4 – ‘□’ button switches the SCENAR device ON and OFF;
- 5 – ‘▼’ button switches between the stimulation modes;
- 6 – ‘+’ button increases the energy level (stimulus strength);
- 7 – ‘-’ button decreases the energy level (stimulus strength).

4.2.3 The information can be displayed on the screen in a **general** or a **single-line** view.

Information is displayed in two lines in a **general** view (Fig.45).

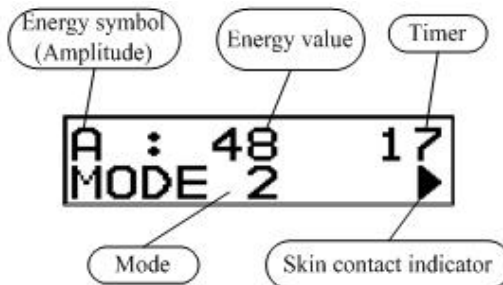

Fig.45

The following data is displayed on the screen:

- a symbol of stimulation energy (amplitude) ('A') and its value in units (from 1 to 250);
- a timer in a 'm ss' format (m – minutes, ss – seconds);
- a set stimulation mode:
 - ◆ 'MODE 1' – the Dosing mode with the constant frequency of 60 Hz and AM;
 - ◆ 'MODE 2' – the stimulation mode with the constant frequency of 90 Hz while the number of pulses in a batch and the gap between the pulses are controlled automatically.



ATTENTION! Set stimulation mode is retained after the SCENAR is switched off, while the energy level is set to minimum.

In a **single-line** view the information is displayed in large font-size. The SCENAR device switches to a **single-line** view:

- when adjusting the stimulation energy (Fig.46);
- when switching between the stimulation modes (Fig.47);
- when working in the Dosing mode ('MODE 1', Fig.48);



Fig.46



Fig.47



Fig.48

When switching to a **single-line** view, the backlight turns on, the skin contact indicator ('▶') is not displayed.

The screen returns to a **general** view after 2 seconds if no button has been pressed.

4.2.4 On the left side of the casing there is a jack (9) intended for connecting the add-on electrodes which can be supplied additionally upon request.



ATTENTION! Only the add-on electrodes produced by the SCENAR manufacturer can be used. Be careful: use only plug-compatible add-on electrodes. Using the incompatible or produced by the other manufacturer add-on electrodes may result in damaging the jack and making the warranty invalid!

4.2.5 To adjust the energy level (from 1 to 250) either press the button step by step (1 step = 1 unit) or press and hold the button (speedy adjustment). A long beep indicates the upper (or lower) energy level limit. Changing of the energy level is accompanied by clicks at the adjustment rate, switching on the backlight and changing ‘A’ value on the screen, meanwhile the information is displayed in a **single-line** view (Fig.49).



ATTENTION! *To avoid uncomfortable and painful sensations of a patient, it is recommended to set the energy to minimum (by pressing and holding the ‘—’ button until the intermittent audio signal sounds) before the start of procedure or when going to treat the most sensitive skin areas.*

Upon returning to a **general** view the set ‘A’ value is displayed in the upper line (Fig.50).



Fig.49

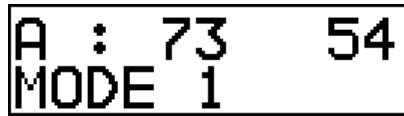

Fig.50

4.2.6 To choose the stimulation mode, press the ‘✔’ button. The backlight flashes on and the set mode – ‘**MODE 1**’ (Fig.51) or ‘**MODE 2**’ (Fig.52) – is displayed on the screen in a **single-line** view. The screen returns to a **general** view after 2 seconds if no button has been pressed. The set mode is indicated in the bottom line (Fig.53).



Fig.51



Fig.52

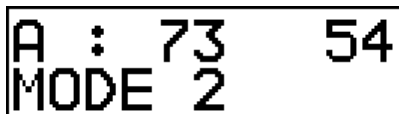

Fig.53

4.2.7 In the ‘**MODE 1**’ mode when the electrode is placed on the skin, a short high-pitch beep sounds. The screen switches to a **single-line** view and the initial state of the timer (‘0’) is indicated on the right (Fig.54). Then the timer starts. In 1-3 sec a short low-pitch beep sounds and the backlight flashes on shortly.



Fig.54

(Optional) SCENAR graphically indicates a level of initial reaction during one second after the second beep:

Reaction level	Indication
Reaction < 18	no indication (Fig.55)
18 <= Reaction < 25	one symbol 'I' displayed (I) (Fig.56)
25 <= Reaction < 40	two symbols 'II' displayed (II) (Fig.57)
40 <= Reaction < 60	three symbols 'III' displayed (III) (Fig.58) and the device emits a single beep every second
60 <= Reaction	four symbols 'IIII' displayed (IIII) (Fig.59) and the device emits double beep every second

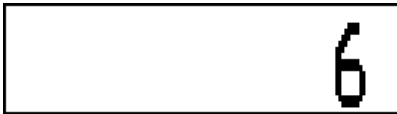

Fig.55



Fig.56

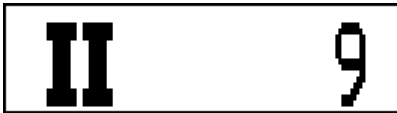

Fig.57



Fig.58



Fig.59



ATTENTION! In fact there is a double indication: a relative value of current reaction to initial one – in the screen and by sounds, and an absolute maximum of reaction – by **clicks**.

4.2.8 In the 'MODE 2' mode continuous stimulation with the frequency 90 Hz is delivered while the number of pulses in a batch and the gap between the pulses are controlled automatically. The '▶' symbol at the right bottom part of the screen indicates a skin contact.

4.2.9 The timer shows duration of continuous contact with the skin in ‘m ss’ format (m – minutes, ss – seconds). In a **general** view the timer is displayed in the upper line on the right (Fig.60). In a **single-line** view the timer is displayed on the right (in the ‘**MODE 1**’ mode during the skin contact) (Fig.61).

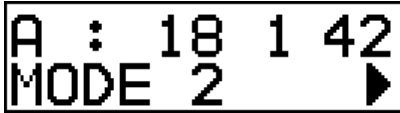

Fig.60



Fig.61

The timer resets when there is a new skin contact, when the timer is overflowed (reaches values of 9 minutes and 59 seconds) and when the device is switched on.

In the ‘**MODE 1**’ mode the timer runs in a **single-line** view only (during the skin contact, Fig.61). When the skin contact is lost, the screen returns to a **general** view, the timer stops and indication remains unchanged.

In the ‘**MODE 2**’ mode when adjusting the energy level while there is a skin contact, the timer is not displayed, but the timing continues.

4.2.10 Enabling/disabling sounds:

- to enable sounds, press the ‘☑’ and ‘+’ buttons simultaneously (the SCENAR device emits a beep);
- to disable sounds, press the ‘☑’ and ‘-’ buttons simultaneously (no sounds).

4.2.11 (Optional) To lock/unlock a keyboard, press and hold the ‘☐’ and ‘-’ buttons (for about 2 sec) until the SCENAR device emits a two-tone descending/ascending beep. When the keyboard is locked the ‘x’ symbol is displayed instead of the ‘:’ (Fig.62).

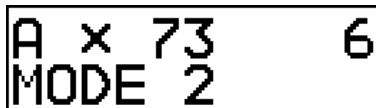

Fig.62

If the SCENAR device switches off automatically, the keyboard will be unlocked when the SCENAR device is switched on next time.

4.2.12 To switch the SCENAR device on with the energy level set before it was switched off, press and hold the ‘☐’ and ‘+’ buttons (for about 2 sec) until the SCENAR device emits an intermittent high-pitch beep.



ATTENTION! When the SCENAR device is switched on with the energy level set before it was switched off, the sound indication is different from default.

5 GETTING STARTED



ATTENTION! Remove the protective film from the built-in electrode before using the SCENAR device.

5.1 SCENAR HOME D AND SCENAR SPORT D

5.1.1 Remove the battery cover and insert the battery observing polarity.

If the battery is installed correctly a beep sounds, the backlight flashes on and the following messages (see Fig.63 and Fig.64) appear on the screen one after the other. After 2 sec another message (see Fig.65) appears. Otherwise reset the SCENAR device (refer to item 5.1.2).

HOME D
OKB RITM

a – for SCENAR Home D

SPORT D
OKB RITM

b – for SCENAR Sport D

Fig.63

U.2.09
11.08.14

Fig.64

A : 1 0
D : 0



Fig.65



ATTENTION! DO NOT use any power adapters to power the SCENAR device from the line supply.

5.1.2 The SCENAR can be reset in case of failure or when it is required to rapidly return to the default settings:

- stimuli amplitude – **minimal**;
- FM mode – **OFF**;
- AM mode – **OFF**;
- Dosing mode – **OFF**;
- stimuli frequency:
 - ◆ SCENAR Home D – **90 Hz**;
 - ◆ SCENAR Sport D – **60 Hz**;
- sound indication – **ON**;
- keyboard – **unlocked**.

To reset to the default settings, press and hold the ‘’ and ‘’ buttons simultaneously (for about 2 sec) until the intermittent audio signal sounds. The reset to the default settings occurs irrespective of whether the SCENAR device is turned on or off.

5.1.3 Repeatedly press the ‘’ button to make sure that the information on the screen changes sequentially as shown on Fig.66...68 (see Fig.66...69 for SCENAR Sport D device). The screen returns to a **general** view (Fig.65) after 2 seconds if no button has been pressed.



Fig.66



Fig.67



Fig.68



Fig.69

5.1.4 Use the ‘+’ or ‘-’ buttons to adjust the stimuli energy. This is accompanied by the backlight flashing on and ‘A’ value displaying in a **single-line** view (Fig.70).



Fig.70

When the mode is preselected (the ‘D’, ‘AM’, ‘FM’ or ‘F’ symbol is displayed in a **single-line** view), press the ‘+’ or ‘-’ buttons to switch the mode on or off respectively.

5.1.5 To switch the SCENAR device off press and hold the ‘’ button (for about 2 sec) until the intermittent audio signal sounds.

5.1.6 The supply voltage is monitored when the SCENAR device is on: if it is lower than (8.1 ± 0.1) V, the short audio signals sound repeatedly (approximately twice a second), indicating that the battery should be replaced. Otherwise, the manufacturer shall bear no liability for incompliance of the SCENAR device performance with the specifications stated in this Operating Manual.



ATTENTION! *The low voltage sound indication is deactivated when changing the settings or if there is a skin contact.*

5.1.7 If the SCENAR device operates as described above, it is ready for use. Otherwise, refer to Chapter 8.

5.1.8 Cleaning & Disinfecting: Wipe the outer surface of the SCENAR device with a cotton swab dampened with 3 % hydrogen peroxide solution with the addition of 0.5 % solution of an approved cleaning liquid. Allow to dry up thoroughly before use.

5.2 SCENAR BASIC D

5.2.1 Remove the battery cover and insert the battery observing polarity.

If the battery is installed correctly a beep sounds, the backlight flashes on and the following messages (see Fig.71 and Fig.72) appear on the screen one after the other. After 2 sec another message (see Fig.73) appears. Otherwise reset the SCENAR device (refer to item 5.2.2).

BASIC D
OKB RITM

Fig.71

U.2.09
11.08.14

Fig.72

A : 1 ◻
MODE 1

Fig.73



ATTENTION! DO NOT use any power adapters to power the SCENAR device from the line supply!

5.2.2 The SCENAR device can be reset in case of failure or when it is required to rapidly choose the default settings:

- stimuli amplitude – **minimal**;
- ‘**MODE 1**’ mode – **ON**.

To reset to the default settings, press and hold the ‘◻’ and ‘◻’ buttons simultaneously (for about 2 sec) until the intermittent audio signal. The reset to the default settings occurs irrespective of whether the SCENAR device is turned on or off.

5.2.3 Repeatedly press the ‘◻’ button to make sure that the modes (‘**MODE 1**’ and ‘**MODE 2**’) are preselected sequentially.

5.2.4 Use the ‘+’ or ‘-’ buttons to adjust the stimuli energy. This is accompanied by the backlight flashing on and ‘A’ value displaying in a **single-line** view (Fig.74).



Fig.74

5.2.5 To switch the SCENAR device off press and hold the ‘□’ button (for about 2 sec) until the intermittent audio signal sounds.

5.2.6 The supply voltage is monitored when the SCENAR device is on: if it is lower than (8.1 ± 0.1) V, the short audio signals sound repeatedly (approximately twice a second), indicating that the battery should be replaced. Otherwise, the manufacturer shall bear no liability for incompliance of the SCENAR device performance with the specifications stated in this Operating Manual.



ATTENTION! *The low voltage sound indication is deactivated when changing the settings or if there is a skin contact.*

5.2.7 If the SCENAR device operates as described above, it is ready for use. Otherwise, refer to Chapter 8.

5.2.8 Cleaning & Disinfecting: Wipe the outer surface of the SCENAR device with a cotton swab dampened with 3 % hydrogen peroxide solution with the addition of 0.5 % solution of an approved cleaning liquid. Allow to dry up thoroughly before use.

6 USING SCENAR DEVICE

6.1 SCENAR HOME D AND SCENAR SPORT D

6.1.1 The Instruction for Use is the main document to be consulted with when delivering treatment with the SCENAR device.

6.1.2 To switch the SCENAR device on press and hold the ‘□’ button (for about 2 sec) until the single beep sounds and the screen looks like as shown in Fig.75. In the bottom line the ‘D’, ‘AM’, ‘FM’ or ‘F’ (for SCENAR Sport D only) symbols may be displayed.

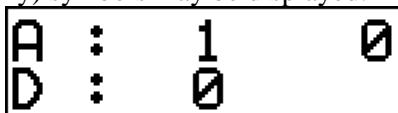

Fig.75



ATTENTION! All set stimulation modes (except for energy) are retained after the SCENAR is switched off.

Reset the SCENAR device to default settings if necessary (when you start treating a new patient) (item 5.1.2).

6.1.3 Place the electrode on the patient's skin. Wait for several seconds to make sure a patient does not have unpleasant sensations. Press and hold the ‘+’ button until the first pricking sensation, vibration or formication at the comfortable level.



ATTENTION! To avoid uncomfortable and painful sensations of a patient, it is recommended to set the energy to minimum (by pressing and holding the ‘-’ button until the intermittent audio signal sounds) before the start of procedure or when going to treat the most sensitive skin areas.



ATTENTION! The SCENAR device switches itself off after 60 seconds if no button has been pressed and there is no skin contact.

6.1.4 When the treatment is over, it is recommended to reset to the default settings (item 5.1.2). Switch the SCENAR device off (item 5.1.5).

6.2 SCENAR BASIC D

6.2.1 The Instruction for Use is the main document to be consulted with when delivering treatment with the SCENAR device.

6.2.2 To switch the SCENAR device on press and hold the ‘□’ button (for about 2 sec) until the single beep sounds and the screen looks like as shown in Fig.76.

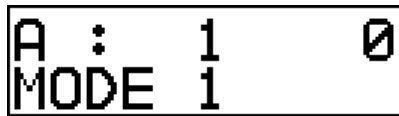

Fig.76



ATTENTION! All set stimulation modes (except for energy) are retained after the SCENAR is switched off.

Reset the SCENAR device to the default settings if necessary (when you start treating a new patient) (item 5.2.2).

6.2.3 Place the electrode on the patient's skin. Wait for several seconds to make sure a patient does not have unpleasant sensations. Press and hold the ‘+’ button until the first pricking sensation, vibration or formication at the comfortable level.



ATTENTION! *To avoid uncomfortable and painful sensations of a patient, it is recommended to set the energy to minimum (by pressing and holding the ‘—’ button until the intermittent audio signal sounds) before the start of procedure or when going to treat the most sensitive skin areas.*



ATTENTION! *The SCENAR device switches itself off after 60 seconds if no button has been pressed and there is no skin contact.*

6.2.4 When the treatment is over, it is recommended to reset to the default settings (item 5.2.2). Switch the SCENAR device off (item 5.2.5).

7 MAINTENANCE

7.1 The SCENAR device shall be repaired only by the manufacturer.

7.2 In case the low battery level is indicated (short beeps twice a sec), remove the battery compartment cover and replace the battery. It is recommended to reset the SCENAR device to the default settings in accordance with:

- item 5.1.2 for SCENAR Home D and SCENAR Sport D,
- item 5.2.2 for SCENAR Basic D.

8 TROUBLESHOOTING

8.1 The possible faults of the SCENAR device and troubleshooting methods are given in Table 2.

Table 2

Fault	Possible cause	Troubleshooting method
The SCENAR device does not operate in accordance with item 5.1.3 (for SCENAR Home D, SCENAR Sport D), item 5.2.3 (for SCENAR Basic D). Or some adjustments fail.	Processor mal-function.	Reset the SCENAR device to the default settings in accordance with: item 5.1.2 for SCENAR Home D and SCENAR Sport D, item 5.2.2 for SCENAR Basic D. If the problem persists, contact the manufacturer.
The SCENAR device emits short beeps twice a second when there is no skin contact.	Low battery.	Replace the battery. If the problem persists after the battery is replaced, contact the manufacturer.
The SCENAR device fails to switch ON.	The battery is discharged.	Replace the battery.
The SCENAR device does not emit any sounds.	The sound is switched OFF.	Reset the SCENAR device to the default settings in accordance with: item 5.1.2 for SCENAR Home D and SCENAR Sport D, item 5.2.2 for SCENAR Basic D. If the problem persists, contact the manufacturer.
The SCENAR device operates but there is no energy on the built-in electrode.	The protective film is not removed from the built-in electrode. The energy level is too low.	Remove the protective film from the built-in electrode. Increase the energy level until comfortable sensations appear.

Continue table 2

Fault	Possible cause	Troubleshooting method
There is no energy on the add-on electrode, while the energy on the built-in electrode is felt.	<p>The add-on electrode malfunction.</p> <p>There is no contact between the plug and jack.</p> <p>The incompatible add-on electrode.</p>	<p>Replace the electrode.</p> <p>Check the connection between the add-on electrode plug and the SCENAR device jack.</p> <p>Use only the add-on electrodes supplied by the manufacturer of the SCENAR device.</p>
There is no energy both on the add-on and built-in electrodes, when the add-on electrode is connected. While the energy on the built-in electrode is felt, if the add-on electrode is not connected.	<p>Short circuit in the add-on electrode cable or plug.</p> <p>The incompatible add-on electrode.</p>	<p>Replace the electrode.</p> <p>Use only the add-on electrodes supplied by the manufacturer of the SCENAR device.</p>
The SCENAR device turns off when there is a skin contact	Bad skin contact or the skin is very dry.	Switch the SCENAR device ON and continue treatment of the target skin area. Repeat the switch-on when necessary.

8.2 Other malfunctions shall be serviced only by the manufacturer.

9 WARRANTY

9.1 The manufacturer guarantees that the SCENAR device complies with this Operating Manual when operated under the conditions specified.

9.2 The warranty period is 24 months from the date of purchase.

9.3 In case of malfunction during the warranty period the SCENAR device with the Warranty card shall be returned to the manufacturer.

9.4 If the Warranty card is not provided, the Warranty seals are broken, or in case of mechanical damage to the SCENAR device no warranty claims shall be accepted and the warranty service shall not be performed.

9.5 The SCENAR device shall be repaired at the expense of the owner in the following cases:

- the SCENAR device was operated in disregard of instructions of the present Operating Manual;
- the manufacturer's seals are broken;
- there is mechanical damage to the SCENAR device;
- the warranty period has expired.

9.6 Customer claims shall be rejected if:

- the product has been subjected to any mechanical damage resulting from an accident, fire, acts of nature, or Force Majeure;
- the manufacturer's serial numbers, labels, seals are damaged or removed, or any other labeling identifying the product is damaged or removed;
- the seals are broken or the product contains any other signs of unauthorised access (repair);
- the product contains the defects resulting from:
 - ◆ improper transportation and storage conditions (no original package during the transportation, hyperhumidity, aggressive environment, any signs of foreign objects, animals and insects, liquid damage, etc.);
 - ◆ improper operating conditions (overload, mechanical, thermal or electric damages, bent contacts, cracks, spallings, dints and impact marks, completely or partially changed shape of the SCENAR device);
 - ◆ using low quality or inappropriate accessories.

10 TRANSPORTATION AND STORAGE

10.1 The transportation of the SCENAR devices to a customer may be carried out by all kinds of covered vehicles, except for the plane compartments that have no heating, at the air temperature from $-50\text{ }^{\circ}\text{C}$ to $+50\text{ }^{\circ}\text{C}$ and relative humidity 100 % at a temperature of $25\text{ }^{\circ}\text{C}$ with a protection from a direct atmospheric precipitation.

10.2 After transportation at negative temperatures, the SCENAR device should be kept in the transport container under normal climatic conditions for not less than 24 hours.

10.3 The SCENAR device shall be stored in the manufacturer's package in a heated room at a temperature of $5\text{ }^{\circ}\text{C}$ to $40\text{ }^{\circ}\text{C}$ and relative humidity of 80 % at $25\text{ }^{\circ}\text{C}$.

ANNEX 1

Guidance and manufacturer's declaration – electromagnetic compatibility (EMC)		
Intended healthcare environments – Professional and Home		
Emissions		
Classification		—
Standard	EN 55011 (idt CISPR 11)	
Class A or B	B	—
Group 1 or 2	1	—
Conducted RF Emissions		N/A NOTE 1
Radiated RF Emissions		PASS
Disturbance Power (if applicable)		N/A NOTE 2
Harmonic Distortion per EN 61000-3-2 (Class A, B, C, D)		N/A NOTE 1
Voltage Fluctuations and Flicker per EN 61000-3-3		N/A NOTE 1
Immunity		
Electrostatic Discharges EN 61000-4-2		PASS
Radiated RF EM Fields and Proximity Wireless fields EN 61000-4-3		PASS
Electrical Fast Transients and bursts EN 61000-4-4		N/A NOTE 3,4
Surges EN 61000-4-5		N/A NOTE 3,5
Conducted Disturbances, induced by RF fields EN 61000-4-6		N/A NOTE 3,4
Voltage Dips and Interruptions EN 61000-4-11		N/A NOTE 1
Rated Power-frequency Magnetic Field EN 61000-4-8		PASS
Supplementary information: NOTE 1) EUT is powered by internal battery 9 V DC NOTE 2) If applicable Radiated RF Emissions, Disturbance Power is not necessary NOTE 3) The test is applicable to all d.c. power PORTS intended to be connected permanently to cables longer than 3 m. NOTE 4) SIP/SOPs whose maximum cable length is less than 3m in length are excluded. NOTE 5) This test applies only to output lines intended to connect directly to outdoor cables.		

Guidance and manufacturer's declaration – electromagnetic immunity		
Immunity test	EN 60601-1-2 test level	Compliance level
Electrostatic discharge (ESD) EN 61000-4-2	± 8 kV contact ± 2 kV, ± 4 kV, ± 8 kV, ± 15 kV air	PASS
Radiated RF EM fields EN 61000-4-3	3 V/m (for Professional Healthcare Facility Environment) 80 MHz to 2.7 GHz 80 % AM at 1 kHz	PASS
	10 V/m (for Home Healthcare Environment) 80 MHz to 2.7 GHz 80 % AM at 1 kHz	PASS
Enclosure port immunity EN 61000-4-3	EN 60601-1-2:2015 Table 9	PASS
Power frequency (50/60 Hz) magnetic field EN 61000-4-8	30 A/m	PASS

