

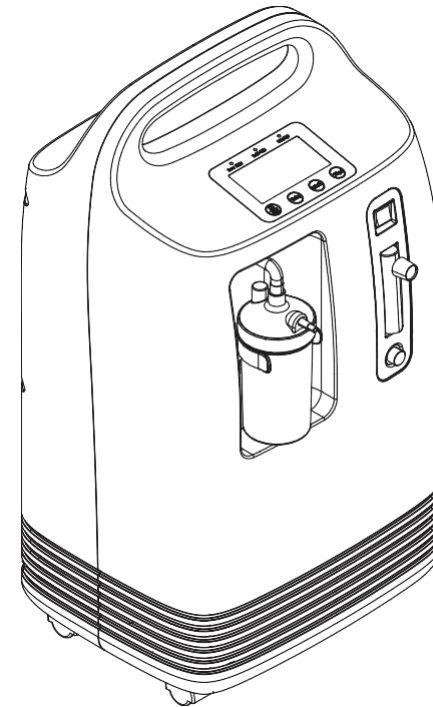

Oxygen Concentrator User Manual



Please read the instruction carefully before use the machine.

Issue Date: 2021.01.21, Ver.1.0

Version : OLV-1-20210121

Table of Contents

1. Product Overview.....	01
2. Safety Overview.....	02
3. Structural Features.....	03
4. Technical Indicators.....	04
5. Product Installation.....	05
6. Product Use.....	06
7. Cleaning & Maintenance.....	13
8. Technical Parameter.....	15
9. Electromagnetic Environment Guidance.....	16
10. Transportation and Storage.....	19
11. Symbols and Meanings for Security Requirements.....	20
12. Troubleshooting Guide.....	21
13. Limited Warranty.....	22
14. Packing List.....	22

1. Product Overview

Welcome to choose our oxygen concentrator !Our oxygen concentrator adopts AC 220V/AC 110V power supply,uses air as raw material and high-quality molecular sieve as adsorbent and adopts the principle pressure swing adsorption (PSA) to directly separate oxygen from nitrogen normal temperature, oxygen of high purity is thereby produced.

In order to ensure the safety and effectiveness of oxygen concentrator, please read this manual carefully before using the machine,so as to have a comprehensive understanding and knowledge of the product performance as well as correct operation and maintenance methods.Please strictly observe relevant safety precautions during installation,use and maintenance.

1. Functions of oxygen

By supplying oxygen to patients,the machine can help the treatment of cardiovascular and cerebrovascular diseases,respiratory diseases,chronic obstructive pneumonia etc.and the rehabilitation of anoxic patients.

Oxygen absorption can improve physical oxygen supply condition and achieve the purpose of oxygenating care. It is suitable for the middle aged and elderly, people with poor physical fitness, pregnant women, students and other people who suffer different degrees of physiological hypoxia. It can also eliminate fatigue and restore somatic function after heavy physical or mental exertion.

2. Scope of application

It is applicable for oxygen concentrator in medical institutions and family etc. for the use of anoxic patients.

3. Product features

1. Plastic casing, novel design, simple operation, stable operation, easy maintenance.
2. Generate oxygen adopting physical methods, with air as raw material, without the use of additives, only needing power supply, with low cost.
3. Adopt pressure swing adsorption (PSA) technology of efficient molecular sieve, with simple process flow and low energy consumption.

4. Specification & model

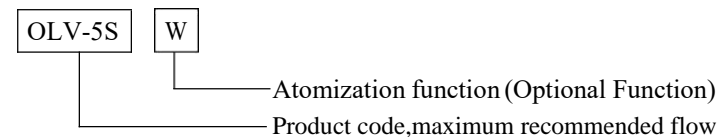

2. Safety Overview

Warning



1. This product can not be used for life support or life sustaining. Patients who can not expressd is comfort or can not hear or see alarm signals require additional care.
2. Oxygen therapy may be harmful under certain conditions. Patients shall correctly control oxygen flow and oxygen absorption time under the guidance of physician.
3. Excessive use of high-purity oxygen has toxic and side effect on human body.
4. People suffering severe carbon monoxide poisoning shall not use this product.
5. To prevent power failure or possible failure of oxygen concentrator, when the patients in urgent need of oxygen and the critically ill patients absorb oxygen using this product, other standby oxygen supply devices (e.g.: oxygen cylinder, oxygen bag, etc.) must be provided.
6. If the oxygen concentrator can not work properly, or if you feel uncomfortable, please stop using immediately and consult physician or supplier to solve the problems.
7. Oxygen is a kind of combustion supporting gas, thus the oxygen concentrator can not be used in places with open flame or the danger of flammability, smoking or open flame is prohibited near people who absorb oxygen.
8. Power supply must comply with electrical safety regulations.
9. Repairs must be performed by the company authorized service personnel only. Unauthorized service could cause injury, invalidate the warranty, or result in costly damage.
10. User must be use the machine according to this user manual.
11. The product in areas with stable power grid. For continuously using this product under unstable power grid, an UPS is recommended.



Manufacturer:

Zhengzhou Olive Electronic Technology Co., Ltd

5th Floor , Block D, Building 18 Henan International
University Science Park (East District), 450001 Zhengzhou,
Henan PEOPLE'S REPUBLIC OF CHINA
Tel: 86 371 86097307

Eu. Rep.:

MedPath GmbH

EC REP

Mies-van-der-Rohe-Strasse 8, 80807 München, GERMANY

13. Limited Warranty

Manufacturer warrants that the system shall be free from defects of workmanship and materials and will perform in accordance with the product specifications for a period of 2 years from the date of manufacture or 5000 hours (which one is earlier). This warranty does not cover damage caused by accident, misuse, abuse, alteration, and other defects not related to material or workmanship.

Manufacturer disclaims all liability for economic loss, loss of profits, overhead, or consequential damages which may be claimed to arise from any sale or use of this product. Some states do not allow the exclusion or limitation of incidental or consequential damages, so the above limitation or exclusion may not apply to you.

14. Packing List

No.	Name	Unit	Qty	Remarks
1	Machine	Set	1	
2	Nasal cannula	PCS	2	
3	Nebulizer	Set	1	Only atomization models
4	Connecting tube of humidifier bottle	PC	1	
5	Humidifier bottle	PC	1	
6	Air filter	PC	1	
7	Hepa filter	PC	1	
8	User manual	PC	1	
9	Warranty card	PC	1	

3. Structural Features

Our oxygen concentrator mainly consists of machine, flow meter and humidifier bottle, as shown Figure 1.

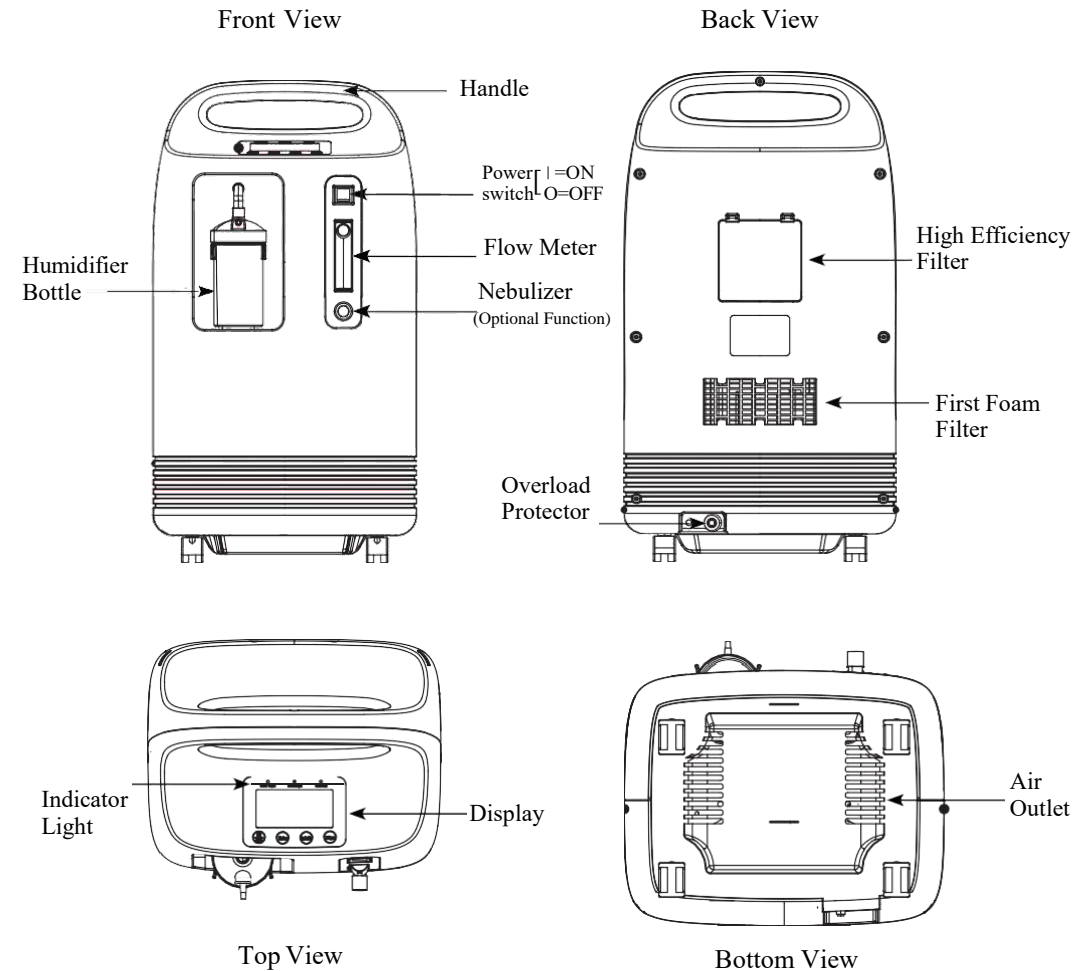

Figure 1

Overload protector: protect the machine from electricity overload.

Display: show the machine working status.

Air filter: prevents dirt, dust, and lint from entering your unit, include first foam filter and high efficiency filter.

12. Troubleshooting Guide

Problem	Possible Cause	What to Do
A. The device is not working when it is turned on. (The Audible Alarm is sounding continuously. All LEDs are off)	The device is not receiving power from the electrical outlet.	Check your household outlet fuse or circuit.
	The unit is not receiving power from the electrical outlet.	Make sure the device is properly plugged in to the electrical outlet.
	Internal part failure.	Connect to a back up oxygen source and contact your provider.
B. The device is not working when it is turned on. (The Audible Alarm is sounding continuously and the red light is illuminated)	Internal part failure.	Connect to a back up oxygen source and contact your provider.
	The oxygen tubing or cannula is faulty.	Inspect and replace the items if necessary
C. Limited oxygen flow to the user without any fault indication	There is a poor connection to a device accessory.	Ensure that all connections are free from leaks.
	The device has detected a high oxygen flow condition.	Turn the flow rate down to your prescribed level. Wait at least 2mins, if the condition persists turn the unit off, connect a back up oxygen source, and call your provider.
D. Yellow LED or Red LED is illuminated and the Audible Alarm is beeping periodically (Only the model with oxygen concentration alarm function)		Connect to a back up oxygen source and contact your provider.
E. If any other problems occur with your oxygen concentrator.		Connect to a back up oxygen source and contact your provider.

NOTE: Please contact the provider or manufacturer if there are any other malfunctions.

4. Technical Indicators

1. Operating environment (oxygen concentration statusindicator)

Ambient temperature: 10 °C ~ 40 °C

Relative humidity: 30% ~ 75%

Atmospheric pressure: 860hPa ~ 1060hPa

Power supply: AC 220V±22V 50Hz ±1Hz

AC 110V±11V 60Hz ±1Hz

There shall be no corrosive gas or strong magnetic field in surrounding environment.

environment.

2. Air requirements

Impurities in raw material air: $\leq 0.3 \text{ mg / cm}^3$

Oil content in air: $\leq 0.01 \text{ ppm}$

3. Product functions

Total working time: Show the total working time through display screen.

Timing: Set oxygen absorption time as required.

Automatic shutdown: Automatic shutdown after reaching preset oxygen concentration time.

Power failure alarm function.

Low voltage alarm function















Voice function.

Circulating pressure failure alarm function (Optional function)

Low oxygen concentration alarm function (Optional function)

Atomization treatment function (Optional function)

11. Symbols and Meanings for Security Requirements

	Warning		CE mark
	Type BF applied part		Class II equipment
O	Off (power)		On (power)
SN	Manufacture's serial number		Authorized representative in the European community
	Date of manufacture		Manufacturer
	Can not be thrown into the trash		This way up
	Fragile		No smoking
	No open flame		Refer to instruction manual/ booklet.
IP21	Protected against access to hazardous parts with a finger. Protected against solid foreign objects of Φ 12.5mm and greater. Protected against vertically falling water drops.		Keep dry

5. Product Installation

1. Unpacking inspection

Open the carton box from top of the packing box, and then take out the oxygen concentrator. Carefully check whether there is any transport damage to the machine and then check the accessories and relevant documents according to the packing list.

2. Installation precautions



Attention

1. Oxygen concentrator shall be installed in indoor ventilating places without dust, corrosive, toxic or harmful gases or smoke. Avoid direct sunlight, and the distance from walls and other objects shall be greater than 10cm.
2. Oxygen concentrator shall not be installed in places with open flame, fire source, danger of flammability or explosion, humidity, too high or too low temperature. Besides, it shall not be used in a closed room(space).
3. No sundries, water or oil containers shall be placed on top of oxygen concentrator.
4. Oxygen concentrator shall not be placed on soft surfaces (e.g. bed, couch) that may cause tilting or sinking, avoid shutdown or oxygen concentration decrease caused by too high temperature due to blockage of air inlet or outlet.
5. Oxygen concentrator shall be placed smoothly, otherwise it will increase the noise during operation.
6. If grid voltage is instable and exceeds the range of 220V-230V AC or 110V AC, please install voltage stabilizer before use.
7. Please use safe and qualified socket and the wiring board with safe electricity certification.

10. Transportation and Storage

1. Attention

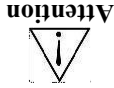

1. Before transportation or storage, pour out the water from humidifier bottle.
2. During transportation and handling, oxygen concentrator shall be kept upright, prohibit inversion or horizontal placing.
3. When the storage temperature is below 10 °C, place the oxygen concentrator in normal working environment for 8 hours before use.
4. If the oxygen concentrator not use for a long time, please inspect it to make sure all functions are normal before use again.

2. Requirements for storage and transportation environment

Ambient temperature	-20 °C ~ 55 °C ;
Relative humidity	≤ 93% ;
Atmospheric pressure	500hPa ~ 1060hPa

3. Transportation

Oxygen concentrator packed completely shall be protected from violent collision and direct contact with rain or snow during transportation.

4. Storage

Oxygen concentrator shall be stored in indoor well-ventilated places without strong sunlight and corrosive gases.

6. Product Use

1. Use precautions



(1). During use, ensure unobstructed exhaust at the bottom of oxygen concentrator, otherwise it may cause internal overheating.

(2). When the output oxygen is less than the maximum recommended flow, oxygen concentration reaches 90%. When the flow exceeds the maximum recommended flow, oxygen concentration will decrease with the increase of flow.

(3). Oxygen concentrator will reach the specified performance after started for 10 minutes.

(4). There will be intermittent exhaust sound (every 6 seconds around) during operation of oxygen concentrator, which is normal.

(5). No oil, grease or other similar substances shall be used on or near oxygen concentrator, and no lubricant other than those recommended by the manufacturer shall be used.

(6). During use, timely add water when water level of humidifier bottle is below the minimum level.

(7). On the atomization mode, machine can't be used for oxygen treatment.

(8). Oxygen concentrator shall not be started frequently, it shall be restarted after stopped for 5 minutes.

(9). When the oxygen concentration is abnormal, stop using, and contact the provider or manufacturer for inspection and maintenance.

(10). Molecular sieve will become aging due to using time and environment etc., causing unrecoverable decrease of oxygen concentration amount. In case of this phenomenon, please contact the provider or manufacturer to replace the molecular sieve.

(11). For long-term stopping of oxygen concentrator, be sure to unplug the power cord. (12). Before operating the unit please make sure the air inlet filter (on the back of unit) is clean .

(13). If liquid is spilled on the device, turn the power off and unplug from electrical outlet before attempting to clean up spill.

(14). If you feel discomfort or are experiencing a medical emergency while undergoing oxygen therapy, seek medical assistance immediately to avoid harm.

(15). Do not share nasal cannula and humidifier with other people to avoid cross infection.

(16). If the oxygen concentrator connected to the power, there should be people to take care of the machine, do not leave the nasal cannula or mask on the bed sheet or chair cushion; oxygen will make the material flammable. When not in use, turn off the oxygen concentrator to prevent local ambient oxygen concentration from increasing.

710	704-787	Pulse modulation 217Hz, 9V/m
745		
780		
810		
870	800-960	Pulse modulation 18Hz, 28V/m
930		
1720		
1845	1700-1990	Pulse modulation 217Hz, 28V/m
1970		
2450	2400-2570	Pulse modulation 217Hz, 28V/m
5240	5100-5800	Pulse modulation 217Hz, 9V/m
5500		
5785		

Table 4 – Input a.c. power Port

Phenomenon	Basic EMC standard	Immunity test levels
		Professional healthcare facility and Home healthcare environment
Electrical fast transients/burst	IEC 61000-4-4	±2 kV 100kHz repetition frequency
Surges Line-to-line	IEC 61000-4-5	±0.5 kV, ±1 kV
Conducted disturbances induced by RF fields	IEC 61000-4-6	3V, 0.15MHz-80MHz 6V in ISM bands and amateur radio bands between 0.15MHz and 80MHz 80%AM at 1kHz
Voltage dips	IEC 61000-4-11	0% UT; 0.5 cycle At 0°, 45°, 90°, 135°, 180°, 225°, 270° and 315°
Voltage interruptions		0% UT; 1 cycle and 70% UT; 25/30 cycles Single phase: at 0°
Voltage interruptions	IEC 61000-4-11	0% UT; 250/300 cycles

(17).When the altitude, ambient temperature, and relative humidity of the use environment exceed the requirements of the use environment specified in this manual, it may cause a decrease in oxygen concentration and shutdown, which will affect the quality of the user's treatment.

(18). For wastes, residues should be handled in accordance with the corresponding national requirements.

(19). Normally life of oxygen concentrator is 5 years .

(20). Oxygen tube and nebulizer kits order by users but user can choose according to manufacturer's guidance.

2. Operation

Control panel of oxygen concentrator is shown in Figure 2.

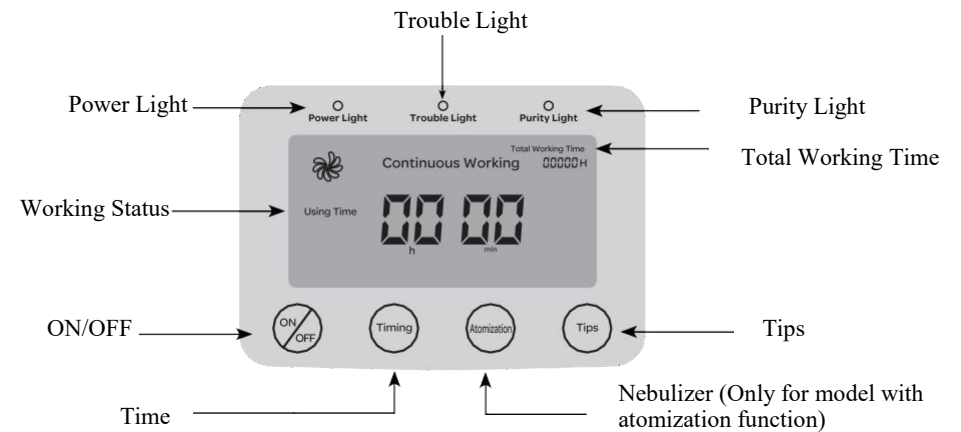

Figure 2

(1). Select a location that allows the concentrator to draw in room air without being restricted. Make sure that the device is at least 10cm away from walls, furniture, and especially curtains that could impede adequate airflow to the device. Do not place the device near any heat source.

(2). After reading this user manual, plug the power cord into a electrical outlet.

(3). Do either Step or Step below.

If you are not using a humidifier, connect your nasal cannula to an oxygen outlet port, as shown in the Figure 3.

② If you are using a humidifier, follow the steps below:

A. Fill the pure water (or distilled water) to your humidifier, the water level is between "Max" and "Min".

B. Lock the humidifier into the sink part, then connect oxygen outlet port to the top of the humidifier, as shown in the Figure 4.

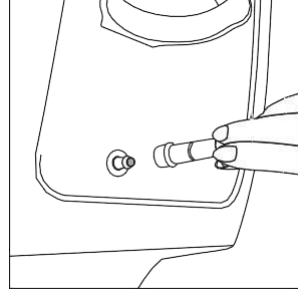

Figure 3

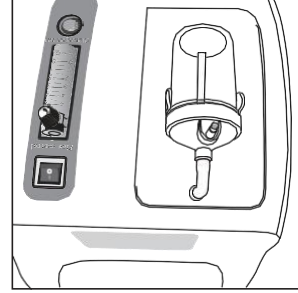

Figure 4

C. Connect your cannula to the humidifier bottle, as shown in the Figure 5.

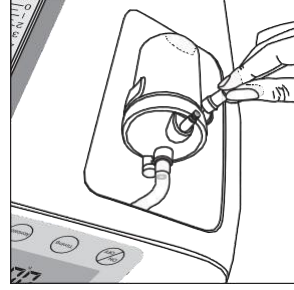

Figure 5

broadcast antennas, before using this equipment, it should be observed to verify that it is operating normally to assure that the equipment remains safe with regard to electromagnetic disturbances throughout the expected service life.

EMI Compliance Table (Table 1)

Phenomenon	Compliance	Professional healthcare facility and Home healthcare environment
RF emissions	CISPR 11 Group 1, Class B	Professional healthcare facility and Home healthcare environment
Harmonic distortion	IEC 61000-3-2 Class A	Professional healthcare facility and Home healthcare environment
Voltage fluctuations and flicker	IEC 61000-3-3 Compliance	Professional healthcare facility and Home healthcare environment

EMS Compliance Table (Table 2-4)

Table 2 - Enclosure Port

Phenomenon	Basic EMC standard	Professional healthcare facility and Home healthcare environment
Electrostatic Discharge	IEC 61000-4-2	±8 kV contact ±2kV, ±4kV, ±8kV, ±15kV air
Radiated RF EM field	IEC 61000-4-3	10V/m 80MHz-2.7GHz 80% AM at 1kHz
Proximity fields from RF wireless communications equipment	IEC 61000-4-3	Refer to table 3
Rated power frequency magnetic fields	IEC 61000-4-8	30A/m 50Hz or 60Hz

Table 3 – Proximity fields from RF wireless communications equipment

Test frequency (MHz)	Band (MHz)	Immunity test levels
385	380-390	Professional healthcare facility and Home healthcare environment
450	430-470	Pulse modulation 18Hz, 27V/m
		FM, ±5kHz deviation, 1kHz sine, 28V/m

9. Electromagnetic Environment Guidance

This electrical medical equipment needs special precautions regarding EMC and put into service according to the EMC information provided in the user manual; The equipment conforms to this IEC 60601-1-2:2014 standard for both immunity and emissions. Nevertheless, special precautions need to be observed:

➤ The equipment with following ESSENTIAL PERFORMANCE is intended used in Home healthcare environment

Essential Performance:

1. The solenoid valve and each indicator light should work normally five minutes after the medical oxygen concentrator is turned on. Oxygen should be output, and alarm function should be available in case of failure.

a) When the output oxygen concentration is lower than 82% (volume fraction), there should be an audible and visual alarm.

b) When the compressor, solenoid valve or pipeline breaks down in the system, it shall make an audible and visual alarm.

c) When the network power is interrupted and the equipment cannot work normally, it shall make a red-light alarm.

2. Temperature rise of medical oxygen concentrator: Under normal working conditions, the maximum temperature of the plastic housing is $\leq 48^{\circ}\text{C}$, and the gas temperature at the oxygen outlet of the oxygen concentrator is $\leq 41^{\circ}\text{C}$.

➤ WARNING: Use of this equipment adjacent to or stacked with other equipment should be avoided because it could result in improper operation. If such use is necessary, this equipment and the other equipment should be observed to verify that they are operating normally”.

➤ The use of accessories, transducers and cables other than those specified or provided by the manufacturer of this equipment could result in increased electromagnetic emissions or decreased electromagnetic immunity of this equipment and result in improper operation.

➤ WARNING: Portable RF communications equipment (including peripherals such as antenna cables and external antennas) should be used no closer than 30 cm (12 inches) to any part of the product, including cables specified by the manufacturer. Otherwise, degradation of the performance of this equipment could result.”

➤ WARNING: If the use location is near (e.g. less than 1.5 km from) AM, FM or TV

(4). Press the power switch to the ON [I] position. Initially, the LED display will illuminate.

(5). Press ON/OFF button, the device is turned on. You can begin breathing from the device immediately even though it typically takes mins to reach oxygen purity specifications. (Figure 6)

(6). Adjust the flow to the prescribed setting by turning the knob on the top of the flow meter until the ball is centered on the line marking the specific flow rate. (Figure 7)

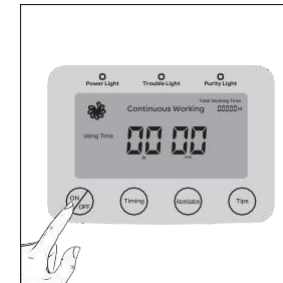

Figure 6



Figure 7

(7). Put on the nasal cannula, then you can use machine properly.

(8). When you are not using the oxygen concentrator, press the power switch to the OFF [O] position.

8. Technical Parameter

Model No.	OLV-3S	OLV-5S	OLV-5SW	OLV-10S	OLV-10SW
	0-3L/min	0-5L/min	0-10L/min		
Maximum recommended Flow	0-3L/min	0-5L/min	0-10L/min		
Oxygen Concentration	93%±3%				
Power Supply	AC 220V±22V 50Hz±1Hz /AC 110V±11V 60Hz±1Hz				
Output Pressure	20kPa-60kPa				
Input Power	350VA	500VA	800VA		
Whole machine noise	45dB(A)	45dB(A)	50dB(A)		
Net Weight	21Kg	23Kg	28Kg		
Dimension	350mm×250mm×670mm				
working System	Continuous flow				
The sound pressure of auditory alarm signal	>40dB(A)				
Atomization quantity	≥0.15ml/min(Only modes with atomization function)				
Release pressure of air compressor safety valve	250kPa ± 50kPa				
Flow range when outlet nominal pressure is 7kPa	0-3L/min	0-5L/min	0-10L/min		
Flow range when outlet nominal pressure is 0	0-3L/min	0-5L/min	0-10L/min		
Device operation above or outside of the voltage, LPM, temperature, humidity and/or altitude values specified may decrease oxygen concentration levels.					

3. Working mode:
Continuous working mode:
Press the "ON/OFF" button, oxygen concentrator will be started and enters into "Continuous" working state. The LCD displays the total working time.

Timer working mode:

After oxygen concentrator is started, press the "timing", oxygen concentrator will enter into timed working mode, for each press of "timing", preset time will be increased 30 minutes (minimum preset time is 1 hour, maximum preset time is 3 hours); Users can preset the time as required.

4. Function:

Tips:

Press "Tips" button more than 3 seconds, to get instructions with voice.

② Atomize(atomization model only):

Press "Atomize" button, the machine will enter into atomize working state.

③ Automatic shutdown:

After reaching the preset time, oxygen concentrator will automatically shut down.

5. Defaults inspection and alarming signal

The oxygen concentrator will give audible and visual alarms when the alarms happen. Please deal with alarms immediately.

A. When power is lost for less than or equal to 30s, the alarm settings prior to the power loss shall be restored automatically

B. The oxygen concentrator is applied with the following default inspection functions

Pressure, circulation defaults

Compressor defaults.

Low oxygen concentration

3. Clean of humidifier bottle

Remove humidifier bottle from the machine. Wash and clean it with warm water.



In case of any water scale, rinse with clean water after descaling.

After cleaning, mix white vinegar with hot water in ratio of 1:3, soak the humidifier bottle in the mixture for 30 mins for sterilization.

During cleaning, pay attention to cleaning the small air hole at the bottom of the core tube in the bottle, so as to keep oxygen unobstructed.

Service: Do not remove the covers of this device. Only authorized provider or trained personnel of the manufacturer can perform maintenance.

(1). The meaning of indicator lights

Symbols	Condition	Indicator lights	Audio indicator	Description
	Good condition: oxygen concentration $\geq 82\%(+3\%)$	Green	None	Normal oxygen output
	$72\%(±3\%) \leq$ oxygen concentration $< 82\%(+3\%)$	Yellow	Intermittent alarming sound	Low oxygen output
	System defaults 1) Oxygen concentration $< 72\%(±3\%)$; 2) Pressure, circulation defaults alarming; 3) Compressor defaults alarming.	Red	Continuous alarming sound	Excessively low oxygen output; Critical fault of device.

(2). Oxygen concentration alarm (Optional function)

When the oxygen concentration $\geq 82\%(3\%)$ --- green light lightens, which means the machine operates smoothly.

② When $72\%(±3\%) \leq$ oxygen concentration $< 82\%(3\%)$ --- yellow light lightens, please contact with the supplier immediately. User can temporarily use the machine, and please ensure there is standby oxygen.

When oxygen concentration $< 72\%(±3\%)$ --- the red light lightens with continuous alarming sound, the machine stops. Please power off the machine immediately and use the standby oxygen, contact with the provider as soon as possible.

NOTE: every time the oxygen concentrator starts, it will be in the most stable condition after about 30 minutes.

(3). Pressure, circulation defaults alarming --- the red light lightens with continuous alarming sound, the machine stops.

Please power off the machine immediately and use the standby oxygen, contact with supplier as soon as possible.

6. How to check oxygen working normally

The operator can check whether the oxygen concentrator is operating normally by the following methods:

(1) After the oxygen concentrator is turned on for 10 minutes, the power indicator and oxygen concentration indicator should be green, and the fault indicator should not be on.

(2) In the state of oxygen generation, block the oxygen outlet of the oxygen concentrator by hand, and the flowmeter should be able to return to the "0" position.

7. Cleaning & Maintenance

If the above two points are met, it means that the oxygen concentrator is operating normally. Otherwise, the oxygen concentrator is not operating normally, you should contact the dealer for inspection or repair.

7.Operating Principle

Oxygen concentrator process flow of our series medical oxygen concentrator is shown in Fig. 8:

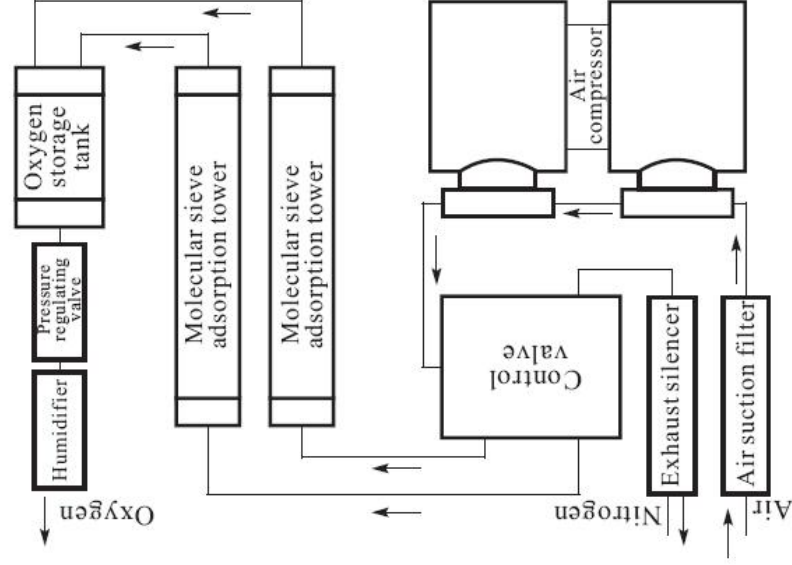

Our series medical oxygen concentrator uses molecular sieve as adsorbent, adopts the principle of pressure swing adsorption (PSA), sends the air after filtration into the molecular sieve adsorption tower for the cyclic process of pressurized adsorption and decompressed desorption, oxygen of high purity is thereby produced.

Figure 8

-12-

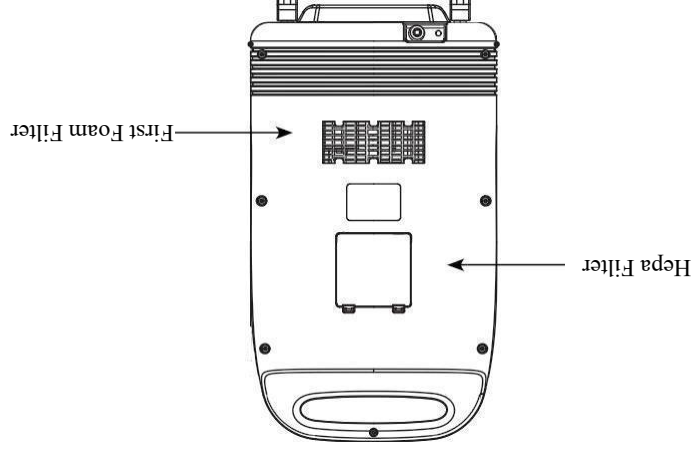

Figure 9

-13-

Warning : It is important to unplug the device before the cleaning and maintenance of oxygen concentrator.
Caution : Excess moisture may impair the proper operation of the device.

1. Clean of Device

Periodically use a damp cloth to wipe down the exterior case of this device.

2. Clean or replace the filter

The cleaning and changing of filter is very important for protecting compressor and molecular sieve and extending the working time of oxygen concentrator. Please timely clean and replace according to requirements.

WARNING: Oxygen concentrator shall not be started before filter are installed. Clean of first foam filter.

The first foam filter should be cleaned once a week. During cleaning, draw out foam filter and rinse with clean water, it can be used after natural drying.

Replace of high efficiency filter(Called Hepa filter)(Figure 9).

When the machine total working time reach to 3000 hours. The user has to replace the Hepa filter. Open the filter window, remove the high Hepa filter, and then replace with a new one.